



AUTOMATION

ACCESSORI DI MONTAGGIO - ACCIAIO INOX
MOUNTING ACCESSORIES - STAINLESS STEEL



MADE IN ITALY

FORCELLA FEMMINA DIN 71752 FILETTO ISO8140 CETOP

FEMALE FORK DIN 71752 THREAD ISO8140 CETOP

FFP...I

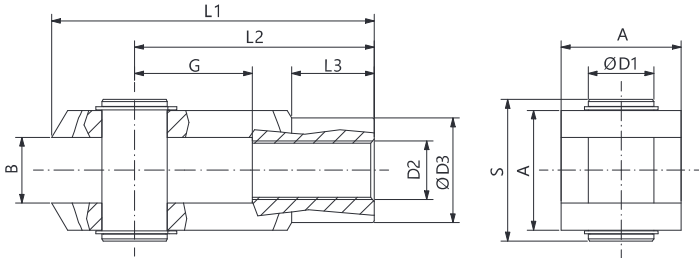

Inox - Stainless steel AISI303

Ø	COD	D2	B	A	ØD1	S	G	L2	L1	L3	ØD3
12 - 16	FFP06100I	M6X1	6	12	6	17	12	24	31	9	10
20	FFP08125I	M8X1,25	8	16	8	21	16	32	42	12	14
25 - 32	FFP10125I	M10X1,25	10	20	10	25	20	40	52	15	18
32	FFP10150I	M10X1,5	10	20	10	25	20	40	52	15	18
40	FFP12125I	M12X1,25	12	24	12	30	24	48	62	18	20
40	FFP12175I	M12X1,75	12	24	12	30	24	48	62	18	20
50 - 63	FFP16150I	M16X1,5	16	32	16	39	32	64	83	24	26
80-100	FFP20150I	M20X1,5	20	40	20	48	40	80	105	30	34
125	FFP27200I	M27X2	30	55	30	65	54	110	148	38	48
160-200	FFP36200I	M36X2	35	70	35	84	72	144	188	40	60

Come ordinare: COD + condizioni fornitura a pag 187 - How to order: COD + supply condition on page 187

TESTA A SNODO DIN ISO12240-4 SERIE K

ROD END BEARING DIN ISO12240-4 K SERIE

TSN...I

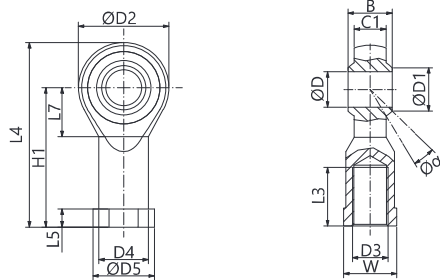

Inox - Stainless steel AISI431

Ø	COD	D3	L3	a°	ØD	ØD1	C1	B	ØD4	ØD5	L5	L7	H1	L4	ØD2
08 - 10	TSN04070I	M4X0,7	10	13°	5	7,7	6	8	9	11	4	10	27	36	18
12 - 16	TSN06100I	M6X1	12	13°	6	8,9	6,75	9	10	13	5	11	30	40	20
20	TSN08125I	M8X1,25	16	14°	8	10,4	9	12	12,5	16	5	13	36	48	24
25 - 32	TSN10125I	M10X1,25	20	13°	10	12,9	10,5	14	15	19	6,5	15	43	57	28
32	TSN10150I	M10X1,5	20	13°	10	12,9	10,5	14	15	19	6,5	15	43	57	28
40	TSN12125I	M12X1,25	22	13°	12	15,4	12	16	17,5	22	6,5	17	50	66	32
40	TSN12175I	M12X1,75	22	13°	12	15,4	12	16	17,5	22	6,5	17	50	66	32
50 - 63	TSN16150I	M16X1,5	28	15°	16	19,3	15	21	22	27	8	23	64	85	42
80-100	TSN20150I	M20X1,5	33	14°	20	24,3	18	25	27,5	34	10	27	77	102	50
125	TSN27200I	M27X2	51	17°	30	34,8	25	37	40	50	15	36	110	145	70
160-200	TSN36200I	M36X2	56	19°	35	37,7	28	43	46	58	17	41	125	165	80

Come ordinare: COD + condizioni fornitura a pag 187 - How to order: COD + supply condition on page 187

DADO ESAGONALE

HEXAGONAL NUT

DES...I

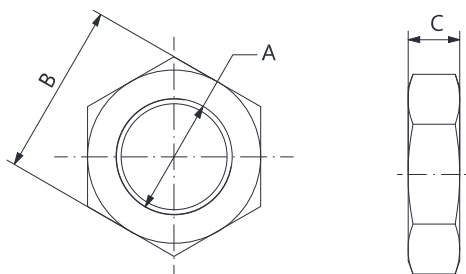

Inox - Stainless steel AISI304

Ø	COD	A	C	B
08 - 10	DES04070I	M4X0,7	3,2	7
12 - 16	DES06100I	M6X1	4	10
20	DES08125I	M8X1,25	5	13
25 - 32	DES10125I	M10X1,25	6	17
32	DES10150I	M10X1,5	6	17
40	DES12125I	M12X1,25	7	19
40	DES12175I	M12X1,75	7	19
50-63	DES16150I	M16X1,5	8	24
80-100	DES20150I	M20X1,5	9	30
125	DES27200I	M27X2	12	41
160-200	DES36200I	M36X2	14	55

Come ordinare: COD + condizioni fornitura a pag 187 - How to order: COD + supply condition on page 187.

DADO ESAGONALE TESTATA

HEXAGONAL COVER NUT

DET...S

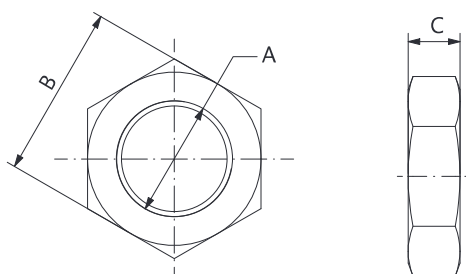

Acciaio zincato - Zinc coated steel

Ø	COD	A	C	B
08 - 10	DET12125S	M12X1,25	5	19
12 - 16	DET16150S	M16X1,5	5	22
20 - 25	DET22150S	M22X1,5	8	27

Come ordinare: COD + condizioni fornitura a pag 187 - How to order: COD + supply condition on page 187.

GHIERA TESTATA

COVER SLOTTED NUT

GHI...I

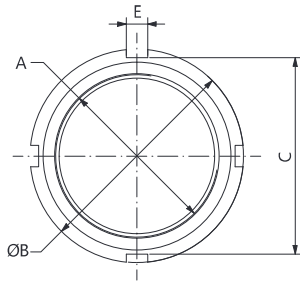

Inox - Stainless steel AISI304

Ø	COD	A	ØB	C	D	E
32	GHI30150S	M30X1,5	45	40	7	5
40	GHI38150S	M38X1,5	50	46	8	5
50 - 63	GHI45150S	M45X1,5	58	52	9	6

Come ordinare: COD + condizioni fornitura a pag 187 - How to order: COD + supply condition on page 187.

ISO6432

FLANGIA MF8

FLANGE MF8

FL1...I

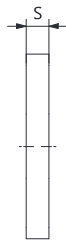
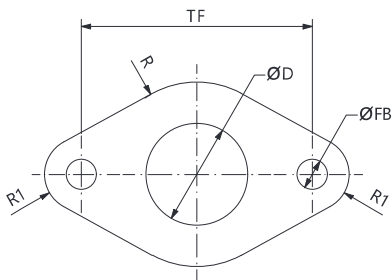

Inox - Stainless steel AISI304

Ø	COD	ØD	ØFB	TF	R	R1	S
08 - 10	FL1008I	12	4,5	30	11	5	3
12 - 16	FL1012I	16	5,5	40	15	6	4
20 - 25	FL1020I	22	6,5	50	20	8	5

Come ordinare: COD + condizioni fornitura a pag 187 - How to order: COD + supply condition on page 187

ISO6432

PIEDINO MS3

PEDESTAL MS3

PD1...I

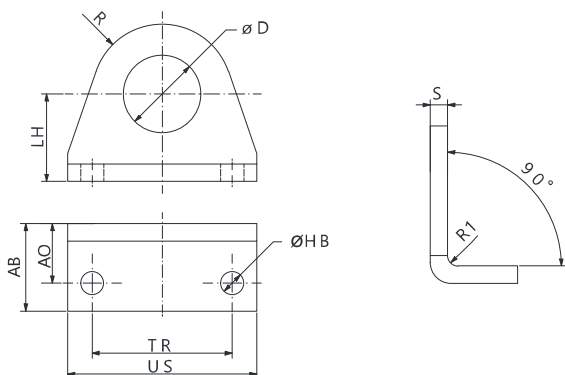

Inox - Stainless steel AISI304

Ø	COD	TR	ØD	S	ØHB	AO	AB	US	LH	R	R1
08 - 10	PD1008I	25	12	3	4,5	11	16	35	16	10	1,5
12 - 16	PD1012I	32	16,1	4	5,5	14	20	42	20	13	2
20 - 25	PD1020I	40	22,1	5	6,6	17	25	54	25	20	2,5

Come ordinare: COD + condizioni fornitura a pag 187 - How to order: COD + supply condition on page 187.

CERNIERA FEMMINA CON PERNO MP3

FEMALE HINGE WITH PIN MP3

CF1...I

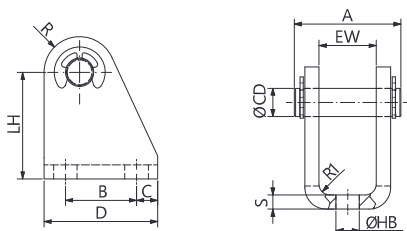

Inox - Stainless steel AISI304

Ø	COD	D	LH	ØCD	S	C	B	EW	ØHB	A	R	R1
08 - 10	CF1008I	22	24	4	2,5	4,75	12,5	8,1	4,5	18	5	1,5
12 - 16	CF1012I	25	27	6	3	5	15	12,1	5,5	24	7	1,5
20 - 25	CF1020I	32	30	8	4	6	20	16,1	6,6	31	10	2

Come ordinare: COD + condizioni fornitura a pag 187 - How to order: COD + supply condition on page 187

CERNIERA FEMMINA MP2

FEMALE HINGE MP2

CFE...I

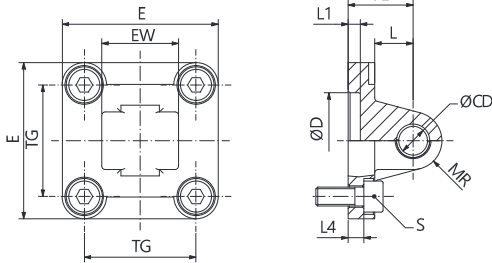

Inox - Stainless steel AISI316

Ø	COD	TG	CB	UB	ØCD	FL	L	ØD	L1	L4	S	MR	E
32	CFE032I	32,5	26	45	10	22	13	30	5	5,5	M6X20	10	45
40	CFE040I	38	28	52	12	25	16	35	5	5,5	M6X20	12	55
50	CFE050I	46,5	32	60	12	27	16	40	5	6,5	M8X20	12	65
63	CFE063I	56,5	40	70	16	32	21	45	5	6,5	M8X20	16	75
80	CFE080I	72	50	90	16	36	22	45	5	10	M10X25	16	95
100	CFE100I	89	60	110	20	41	27	55	5	10	M10X25	20	115
125	CFE125I	110	70	130	25	50	30	60	7	10	M12X25	25	140
160	CFE160I	140	90	170	30	55	35	65	7	10	M16X30	25	180
200	CFE200I	175	90	170	30	60	35	75	7	11	M16X30	25	220

Come ordinare: COD + condizioni fornitura a pag 187 - How to order: COD + supply condition on page 187

CERNIERA MASCHIO MP4

MALE HINGE MP4

CMA...I

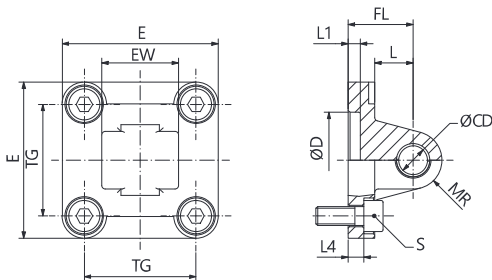

Inox - Stainless steel AISI316

Ø	COD	TG	EW	ØCD	FL	L	ØD	L1	L4	S	MR	E
32	CMA032I	32,5	26	10	22	13	30	5	5,5	M6X20	10	45
40	CMA040I	38	28	12	25	16	35	5	5,5	M6X20	12	52
50	CMA050I	46,5	32	12	27	16	40	5	6,5	M8X20	12	65
63	CMA063I	56,5	40	16	32	21	45	5	6,5	M8X20	16	75
80	CMA080I	72	50	16	36	22	45	5	10	M10X25	16	95
100	CMA100I	89	60	20	41	27	55	5	10	M10X25	20	115
125	CMA125I	110	70	25	50	30	60	7	10	M12X25	25	140
160	CMA160I	140	90	30	55	35	65	7	10	M16X30	25	180
200	CMA200I	175	90	30	60	35	75	7	11	M16X30	25	220

Come ordinare: COD + condizioni fornitura a pag 187 - How to order: COD + supply condition on page 187.

ISO15552

ARTICOLAZIONE A SQUADRA AB7 CETOP RP107P

SQUARE JOINT AB7 CETOP RP107P

ARQ...I

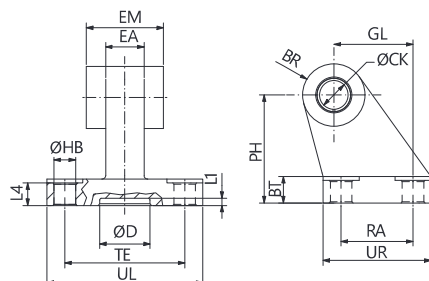

Inox - Stainless steel AISI316

Ø	COD	ØCK	EM	BR	PH	GL	ØHB	L4	BT	TE	RA	ØD	L1	UL	UR	EA
32	ARQ032I	10	26	10	32	21	6,6	6,4	8	38	18	21	3	51	31	10
40	ARQ040I	12	28	11	36	24	6,6	8,4	10	41	22	21	3	54	35	12
50	ARQ050I	12	32	13	45	33	9	10,4	12	50	30	21	3	65	45	16
63	ARQ063I	16	40	15	50	37	9	12,4	14	52	35	21	3	67	50	16
80	ARQ080I	16	50	15	63	47	9	12,4	14	66	40	21	3	86	60	20
100	ARQ100I	20	60	19	71	55	11	14,5	15	76	50	11	3	96	70	20
125	ARQ125I	25	70	22,5	90	70	14	16,8	20	94	60	21	3	124	90	30

Come ordinare: COD + condizioni fornitura a pag 187 - How to order: COD + supply condition on page 187

PERNO ISO AA4

ISO PIN AA4

PRI...I

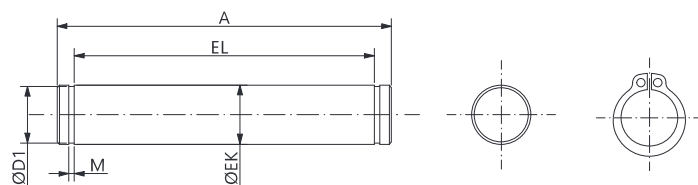

Inox - Stainless steel AISI316

Ø	COD	ØEK	EL	ØD1	M	A
32	PRI032	10	46	9,6	1,1	53
40	PRI040	12	53	11,5	1,1	60
50	PRI050	12	61	11,5	1,1	68
63	PRI063	16	71	15,2	1,1	78
80	PRI080	16	91	15,2	1,1	98
100	PRI100	20	111	19	1,3	118
125	PRI125	25	132	23,9	1,3	139
160-200	PRI160	30	172	28,6	1,6	180
250	PRI250	40	202	37,5	1,85	214
320	PRI320	45	222	42,5	1,85	234

Come ordinare: COD + condizioni fornitura a pag 187 - How to order: COD + supply condition on page 187.

CERNIERA FEMMINA STRETTA AB6

NARROW FEMALE HINGE AB6

CFS...I

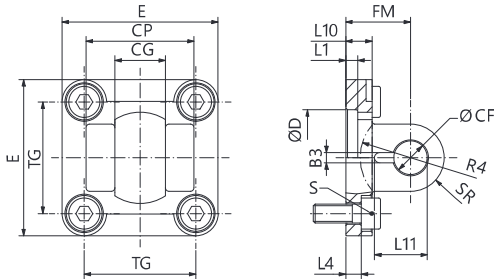

Inox - Stainless steel AISI316

Ø	COD	E	CP	CG	TG	FM	L1	L10	L4	ØD	ØCF	B3	L11	SR	R4	S
32	CFS032I	45	34	14	32,5	22	5	8	5,5	30	10	3,3	16,5	9,5	17	M6X20
40	CFS040I	55	40	16	38	25	5	8	5,5	35	12	4,3	18	12	20	M6X20
50	CFS050I	65	45	21	46,5	27	5	10	6,5	40	16	4,3	23	14	22	M8X20
63	CFS063I	75	51	21	56,5	32	5	10	6,5	45	16	4,3	23	17	25	M8X20
80	CFS080I	95	65	25	72	36	5	13	10	45	20	4,3	27	21	30	M10X25
100	CFS100I	115	75	25	89	41	5	13	10	55	20	4,3	27	21	32	M10X25
125	CFS125I	140	97	37	110	50	7	16	10	60	30	6,3	40	29	42	M12X25

Come ordinare: COD + condizioni fornitura a pag 187 - How to order: COD + supply condition on page 187

PERNO ANTIROTAZIONE AA6

ANTIROTATION PIN AA6

PRA...I

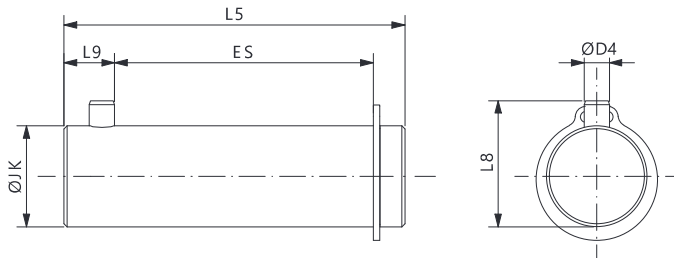

Inox - Stainless steel AISI316

Ø	COD	ØD4	L8	ØJK	L5	L9	ES
32	PRA032	3	14	10	41	6,5	30,5
40	PRA040	4	16	12	48	8	36
50	PRA050	4	20	16	54	8	41
63	PRA063	4	20	16	60	8	47
80	PRA080	4	24	20	75	8	61
100	PRA100	4	24	20	85	8	71
125	PRA125	6	36	30	110	12	91

Come ordinare: COD + condizioni fornitura a pag 187 - How to order: COD + supply condition on page 187.
Ø160-320 su richiesta in acciaio inox / on request in stainless steel

ISO15552

CERNIERA MASCHIO STRETTA CON TESTINA SNODATA MP6

NARROW MALE HINGE WITH SPHERICAL HEAD MP6

CMS...I

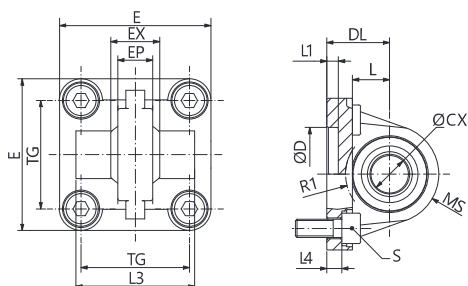

Inox - Stainless steel AISI316

Ø	COD	TG	ØCX	DL	L	EX	EP	S	L4	D	L1	E	MS	L3	R1
32	CMS032I	32,5	10	22	12	14	10,5	M6X20	5,5	30	5	45	16	-	-
40	CMS040I	38	12	25	15	16	12	M6X20	5,5	35	5	55	18	-	-
50	CMS050I	46,5	16	27	15	21	15	M8X20	6,5	40	5	65	21	51	19
63	CMS063I	56,5	16	32	20	21	15	M8X20	6,5	45	5	75	23	-	-
80	CMS080I	72	20	36	20	25	18	M10X25	10	45	5	95	28	74	24
100	CMS100I	89	20	41	25	25	18	M10X25	10	55	5	115	30	140	32
125	CMS125I	110	30	50	30	37	25	M12X25	10	60	7	140	40	-	-

Come ordinare: COD + condizioni fornitura a pag 187 - How to order: COD + supply condition on page 187.

ARTICOLAZIONE A SQUADRA CON TESTINA SNODATA DIN648K

SQUARE JOINT WITH SPHERICAL HEAD DIN648K

ARS...I

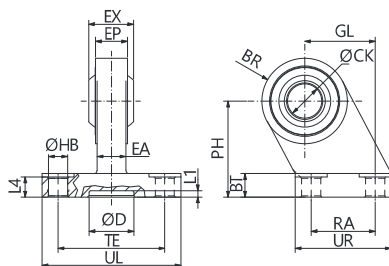

Inox - Stainless steel AISI316

Ø	COD	ØHB	RA	UR	GL	BT	PH	TE	UL	BR	EP	ØCK	L4	ØD	L1	EA	EX
32	ARS032I	6,6	18	31	21	10	32	38	51	15	10,5	10	8,5	20	5	8,5	14
40	ARS040I	6,6	22	35	24	10	36	41	54	18	12	12	8,5	25	5	10	16
50	ARS050I	9	30	45	33	12	45	50	65	20	15	16	10,5	30	5	13,5	21
63	ARS063I	9	35	50	37	12	50	52	67	23	15	16	10,5	30	5	13,5	21
80	ARS080I	11	40	60	47	14	63	66	86	27	18	20	11,5	45	5	15	25
100	ARS100I	11	50	70	55	15	71	76	96	30	18	20	12,5	55	5	15	25
125	ARS125I	13,5	60	90	70	20	90	94	124	40	25	30	17	65	7	20	37

Come ordinare: COD + condizioni fornitura a pag 187 - How to order: COD + supply condition on page 187.

FLANGIA MF1-MF2

FLANGE MF1-MF2

FL2...I

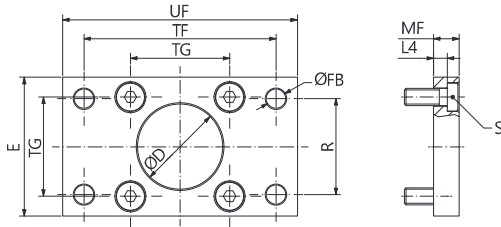

Inox - Stainless steel AISI304

Ø	COD	TG	ØD	ØFB	R	TF	L4	S	UF	E	MF
32	FL2032I	32,5	30	7	32	64	5	M6X20	80	45	10
40	FL2040I	38	35	9	36	72	5	M6X20	90	52	10
50	FL2050I	46,5	40	9	45	90	6,5	M8X20	110	65	12
63	FL2063I	56,5	45	9	50	100	6,5	M8X20	120	75	12
80	FL2080I	72	45	12	63	126	9	M10X25	150	95	16
100	FL2100I	89	55	14	75	150	9	M10X25	170	115	16

Come ordinare: COD + condizioni fornitura a pag 187 - How to order: COD + supply condition on page 187
*Ø125 - 320 a richiesta - *Ø125 - 320 on request

PIEDINO BASSO MS1

LOW-RISE PEDESTAL MS1

PDB...I

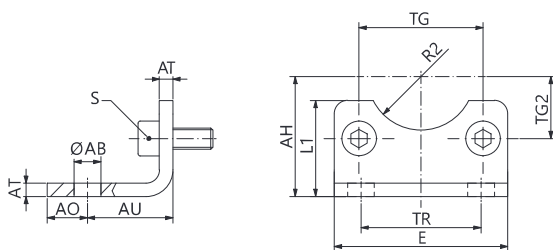

Inox - Stainless steel AISI304

Ø	COD	TG	TG2	AH	R2	ØAB	AO	AU	TR	AT	S	L1	E
32	PDB032I	32,5	16,25	32	15	7	11	24	32	A	M6X16	30	45
40	PDB040I	38	19	36	17,5	10	8	28	36	4	M6X16	30	52
50	PDB050I	46,5	23,25	45	20	10	15	32	45	5	M8X20	36	65
63	PDB063I	56,5	28,25	50	22,5	10	13	32	50	5	M8X20	35	75
80	PDB080I	72	36	63	22,5	12	14	41	63	6	M10X20	47	95
100	PDB100I	89	44,5	71	27,5	14,5	16	41	75	6	M10X20	53	115
125	PDB125I	110	55	90	30	16,5	25	45	90	8	M12X25	70	140
160	PDB160I	140	70	115	32,5	18,5	15	60	115	10	M16X30	100	180
200	PDB200I	175	87,5	135	37,5	24	30	70	135	12	M16X30	109	220

Come ordinare: COD + condizioni fornitura a pag 187 - How to order: COD + supply condition on page 187.

ISO15552

CERNIERA INTERMEDIA REGOLABILE MT4

INTERMEDIATE HINGE ADJUSTABLE MT4

CIR...I

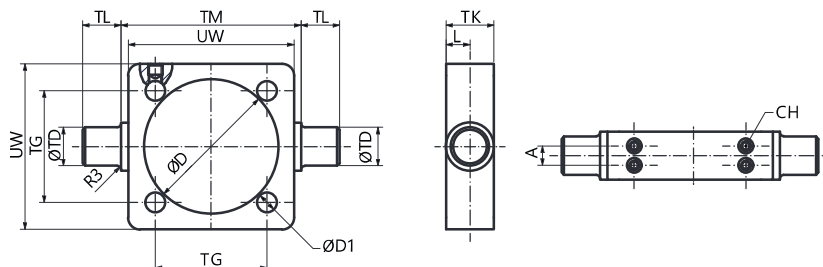

Inox - Stainless steel AISI316

Ø	COD	TG	TM	TL	TK	ØTD	ØD	ØD1	UW
32	CIR032I	32,5	50	12	15	12	37	6,25	46
40	CIR040I	38	63	16	20	16	46	6,25	59
50	CIR050I	46,5	75	16	20	16	56	8,25	69
63	CIR063I	56,5	90	20	25	20	69	8,25	84
80	CIR080I	72	110	20	25	20	87	10,25	102
100	CIR100I	89	132	25	30	25	107	10,25	125
125	CIR125I	110	160	25	32	25	134	12,25	155
160	CIR160I	140	200	32	40	32	171	16,25	190
200	CIR200I	175	250	32	40	32	214	16,25	240

Come ordinare: COD + condizioni fornitura a pag 187 - How to order: COD + supply condition on page 187